

# DMG



**Metal**

## Halide Downlights

Adjustable multi-lamps recessed luminaires, designed for use with metal halide lamps. DMG Series can be customised and suited to individual needs and lighting requirements of particular areas such as in retails, display and exhibition areas. Available in square frame with 1, 2, 3 or 4 optical assemblies including coloured filters.

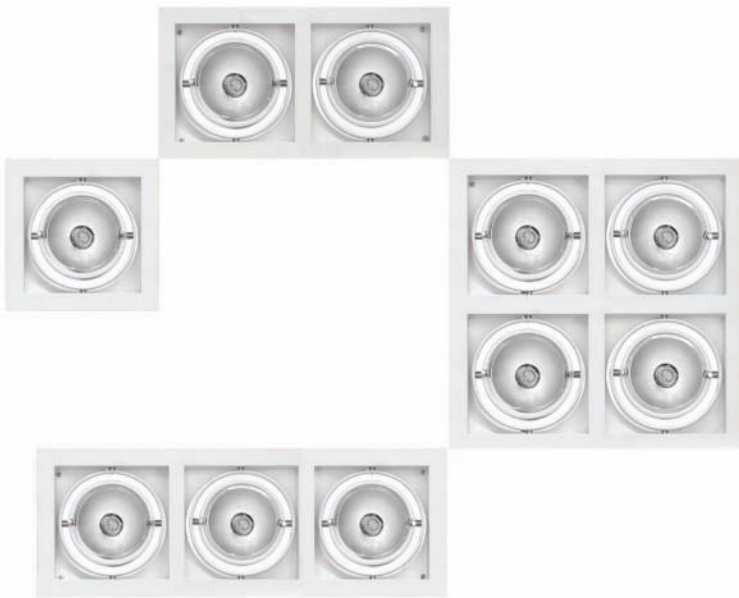

DMG Downlights are available in square or circular frame options, with injection aluminum and electrostatic powder paint coated body, with (99.9%) high pure aluminum reflector and adjustable inner frame and tempered glass.

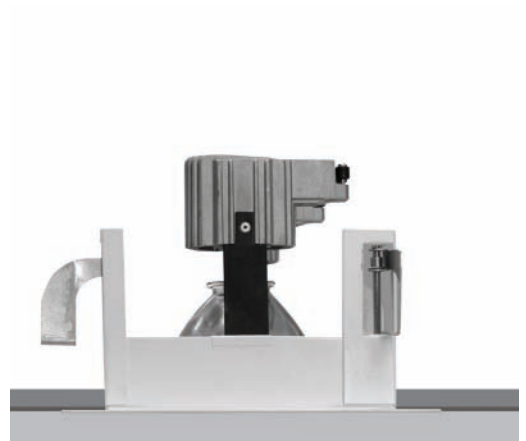

The heat that comes into being metal halide lamps, is sent away from the light source without any negative effect thanks to special cooler element made of injection aluminum.

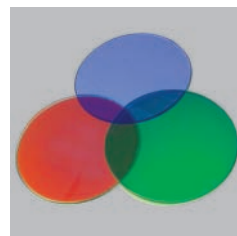

As an other alternative, different lighting applications can be achieved in ambients by using dichroic glass with special effect.

## METAL HALIDE DOWNLIGHTS / DMG-M



## DMG-M 1



## Description

**Body:** High quality steel 0.8 mm painted with 50 micron electrostatic powder paint.

**Reflector:** Manufactured with 1 mm thick high pure (99.9%) aluminum.

**Glass:** 3.2 mm thick tempered front glass.

Code	Lamp	Color
<b>Narrow Angle Reflector</b>		
DMG M1/135 D	1x35W HCl-T	White
DMG M1/170 D	1x70W HCl-T	White
<b>Wide Angle Reflector</b>		
DMG M1/135 G	1x35W HCl-T	White
DMG M1/170 G	1x70W HCl-T	White

**Box Dimensions**

Inside box 1 PCS.  
DMG M1 240x240x230 mm

**Cut-out:** 180x180 mm

**Weight**

DMG M1 1.400 gr

**Protection:** IP20

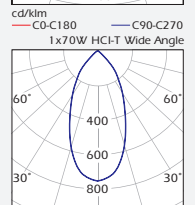
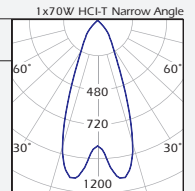

## Dimensions

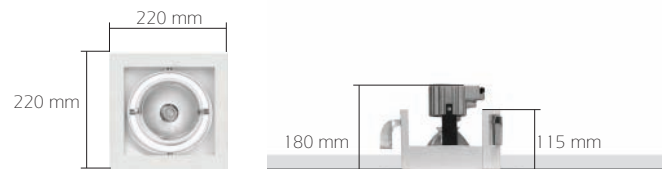

## DMG-M 2



## Description

**Body:** High quality steel 0.8 mm painted with 50 micron electrostatic powder paint.

**Reflector:** Manufactured with 1 mm thick high pure (99.9%) aluminum.

**Glass:** 3.2 mm thick tempered front glass.

Code	Lamp	Color
<b>Narrow Angle Reflector</b>		
DMG M2/235 D	2x35W HCl-T	White
DMG M2/270 D	2x70W HCl-T	White
<b>Wide Angle Reflector</b>		
DMG M2/235 G	2x35W HCl-T	White
DMG M2/270 G	2x70W HCl-T	White

**Box Dimensions**

Inside box 1 PCS.  
DMG M2 240x450x230 mm

**Cut-out:** 380x180mm

**Weight**

DMG M2 2.850 gr

**Protection:** IP20

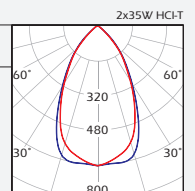

## Dimensions

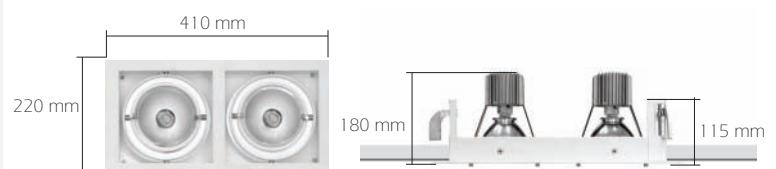



## DMG-M3

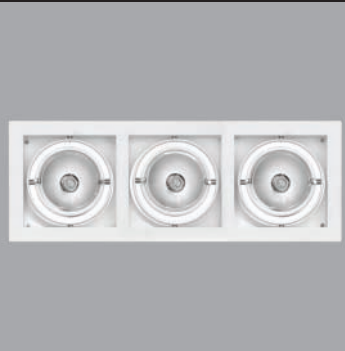

### Description

**Body:** High quality steel 0.8 mm, painted with 50 micron electrostatic powder paint.  
**Reflector:** Manufactured with 1 mm thick high pure (99.9%) aluminum.  
**Glass:** 3.2 mm thick tempered front glass.

### Code

#### Narrow Angle Reflector

DMG M3/335 D 3x35W HCl-T  
 DMG M3/370 D 3x70W HCl-T

#### Wide Angle Reflector

DMG M3/335 G 3x35W HCl-T  
 DMG M3/370 G 3x70W HCl-T

### Color

White  
 White

White  
 White

### Box Dimensions

Inside box 1 PCS.  
 DMG M3 240x640x230 mm

**Cut-out:** 570x180 mm

### Weight

DMG M3 4.200 gr

**Protection: IP20**

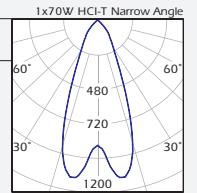

cd/km  
 — C0-C180 — C90-C270  
 1x70W HCl-T Wide Angle

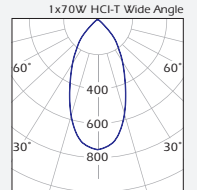

cd/km  
 — C0-C180 — C90-C270

### Dimensions

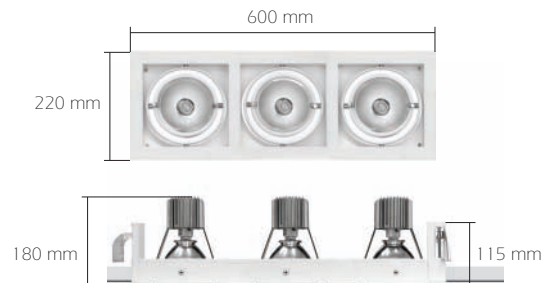

## DMG-M4



### Description

**Body:** High quality steel 0.8 mm, painted with 50 micron electrostatic powder paint.  
**Reflector:** Manufactured with 1 mm thick high pure (99.9%) aluminum.  
**Glass:** 3.2 mm thick tempered front glass.

### Code

#### Narrow Angle Reflector

DMG M4/435 D 4x35W HCl-T  
 DMG M4/470 D 4x70W HCl-T

#### Wide Angle Reflector

DMG M4/435 G 4x35W HCl-T  
 DMG M4/470 G 4x70W HCl-T

### Color

White  
 White

White  
 White

### Box Dimensions

Inside box 1 PCS.  
 DMG M4 450x450x230 mm

**Cut-out:** 380x380 mm

### Weight

DMG M4 5.700 gr

**Protection: IP20**

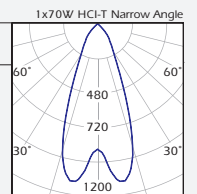

cd/km  
 — C0-C180 — C90-C270  
 1x70W HCl-T Wide Angle

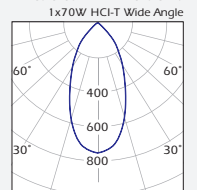

cd/km  
 — C0-C180 — C90-C270

### Dimensions

